

COMMON

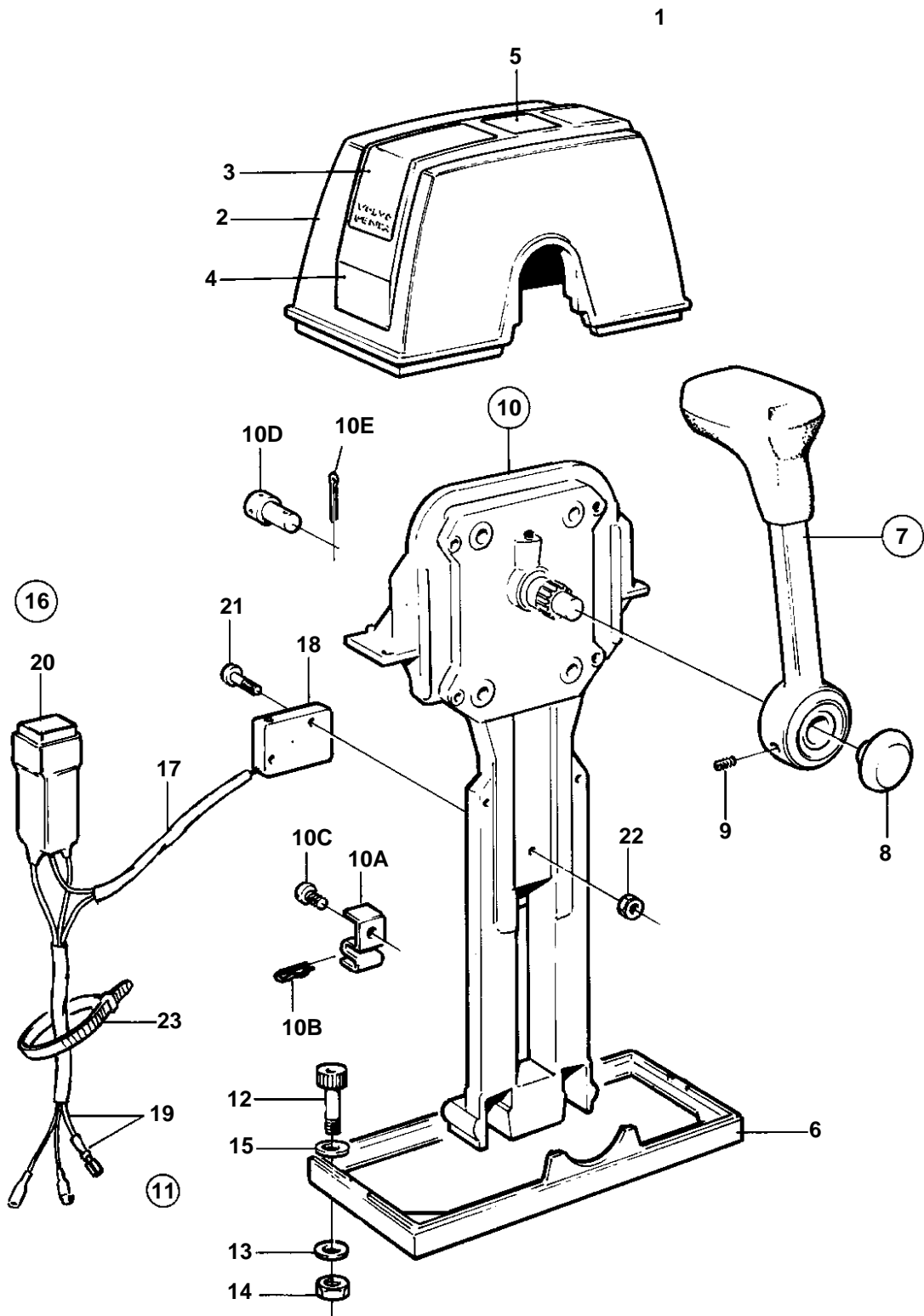

15094

COMMON

REF	PART NO.	QTY	DESCRIPTION	SEE SEC.	NOTES
1	853168	1	Mounting kit		For single installation.
2	1140046	1	• Cover		
3	851896	2	• • Decal		
4		1	• • Cover plate		
5		1	• • Decal		
6	839474	1	• • Plate		
7	852347	1	• Lever		
8		1	• • Push button	266	Included in complete handle.
9		1	• • Screw		Included in complete handle.
10	851600	1	• Control		
10A	853423	1	• • Retainer		
10B	852924	1	• • Clip		
10C	839664	1	• • Screw		
10D	839638	1	• • Cube		
10E	17253	1	• • Cotter pin		
11		1	• Screw kit		
12	947671	4	• • Allen head screw		
13	960138	4	• • Washer		
14	955780	4	• • Nut		
15	940090	4	• • Washer		
16	855352	1	Neutral posit contac		
17	839619	1	• Cable kit		
18	850200	1	• • Switch		
19		X	• • Cables and terminals		SE GROUP 30
20	876037	1	• Relay kit		
21	946177	2	• Screw		
22	947536	2	• Nut		
23	948211	X	• Strip clamp		